

HP-350

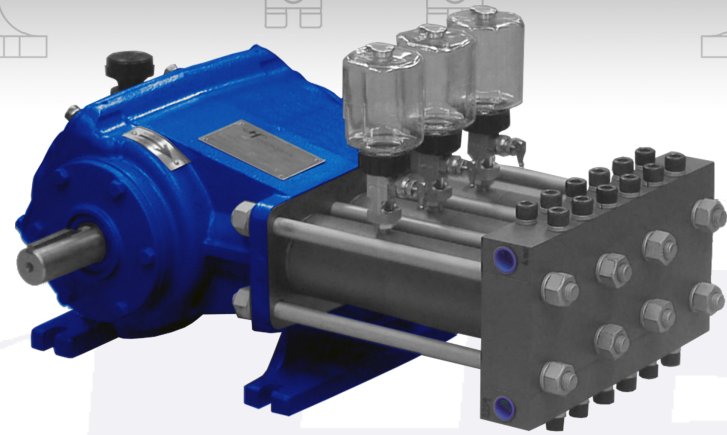

HP-1050

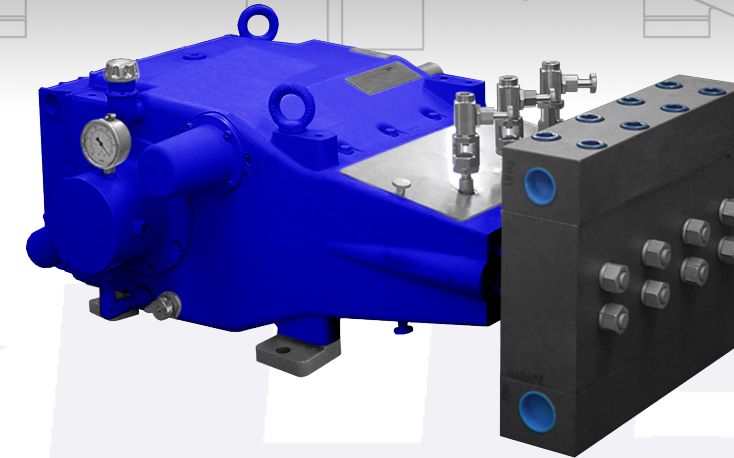

Features

- Pressure to 30,000 psi*
- Durable and Compact
- Splash or Pressurized Lubrication Systems
- Easy Field Maintenance
- High Output Efficiency
- Corrosion Resistant Hardware

Applications

- Methanol Injection
- Hydrostatic Testing
- Chemical Injection
- Downhole Equalization
- Flushing
- HPU Charging
- Hydroforming

More

- Maximum Continuous Power 35 HP
- Maximum Intermittent Power 40 HP
- Maximum Continuous Input RPM 400 RPM
- Maximum Intermittent Input RPM 450 RPM
- 1.75" Stroke Length
- Available with 4-bolt SAE "C" female splined shaft for direct coupling of hydraulic motors

Features

- Pressure to 27,000 psi*
- Internal Helical Gear Reduction
- Durable and Compact
- Pressurized Lubrication Systems
- Easy Field Maintenance
- High Output Efficiency
- Corrosion Resistant Hardware

Applications

- Methanol Injection
- Hydrostatic Testing
- Chemical Injection
- Downhole Equalization
- Flushing
- HPU Charging
- Well Service

More

- Maximum Continuous Power 200 HP
- Maximum Intermittent Power 250 HP
- Internal Gear Ratio 4.25
- Maximum Continuous Input RPM 1530 RPM
- Maximum Intermittent Input RPM 2000 RPM
- 3.75" Stroke Length

Plunger Dia.	Maximum Pressure PSI	Gallons Per Input Revolution	Volumes																		
			450 RPM		400 RPM		100 RPM		50 RPM												
			GPM	BPD	GPM	BPD	GPM	BPD	GPM	BPD	Plunger Dia.	Maximum Pressure PSI	Gallons Per Input Revolution	Volumes							
			GPM	BPD	GPM	BPD	GPM	BPD	GPM	BPD							2000 RPM		1800 RPM		900 RPM
3/8"	30,000*	.0025	1.12	38.39	1.00	34.28	.25	8.57	.12	4.11	3/4"	27,000*	.0050	10.63	364	10.12	347	4.50	154	.51	17.36
7/16"	30,000*	.0034	1.53	52.44	1.36	46.62	.34	11.66	.17	5.83	7/8"	25,000*	.0068	14.47	496	13.78	472	6.21	213	.69	23.62
1/2"	22,500*	.0044	1.98	67.89	1.76	60.34	.44	15.09	.22	7.54	1"	20,000	.0089	18.90	648	18.00	617	8.10	278	.90	30.86
5/8"	15,000	.0070	3.15	108.00	2.80	96.00	.70	24.00	.35	12.00	1-1/8"	15,750	.0113	23.92	820	22.78	781	10.17	349	1.14	39.05
3/4"	10,000	.0100	4.50	154.29	4.00	137.14	1.00	34.29	.50	17.14	1-3/16"	14,000	.0126	26.65	914	25.38	870	11.34	389	1.27	43.51
7/8"	8,000	.0137	6.16	211.00	5.48	188.00	1.37	47.00	.68	23.50	1-1/4"	12,500	.0140	29.53	1,012	28.12	964	12.60	432	1.41	48.21
											1-3/8"	10,500	.0170	35.73	1,225	34.03	1,167	15.32	525	1.70	58.34
											1-1/2"	9,000	.0202	42.52	1,458	40.50	1,389	18.18	623	2.02	69.43

Hydroplex Corporation
 230 W. Gloria Switch Rd.
 Lafayette, LA 70507
 337-233-0626
 www.hydroplexpumps.com

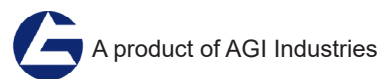

Above flowrates based upon 100% volumetric efficiency
 *Please consult with factory for pressures over 20,000 psi

Hydroplex Corporation
 230 W. Gloria Switch Rd.
 Lafayette, LA 70507
 337-233-0626
 www.hydroplexpumps.com

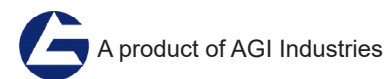

Above flowrates based upon 100% volumetric efficiency
 *Please consult with factory for pressures over 20,000 psi

HP-550

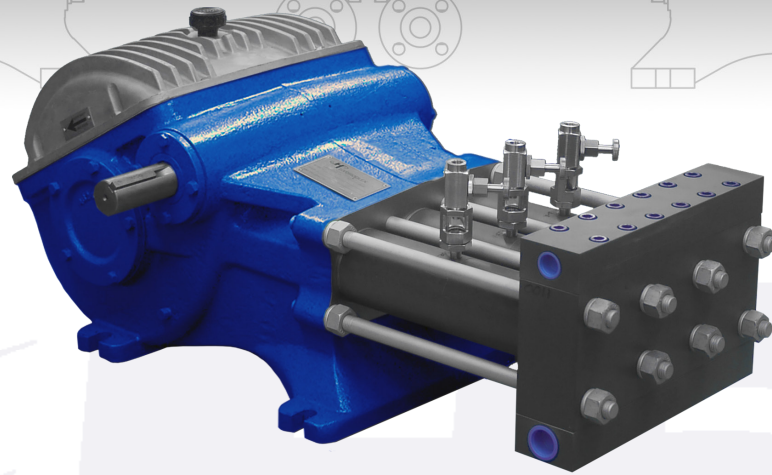
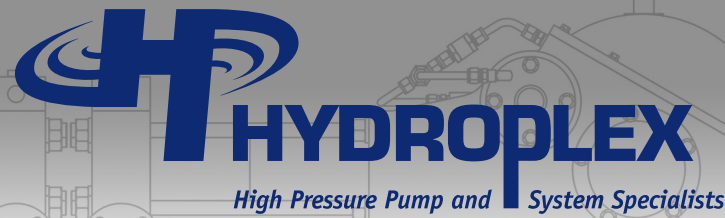

HP-950

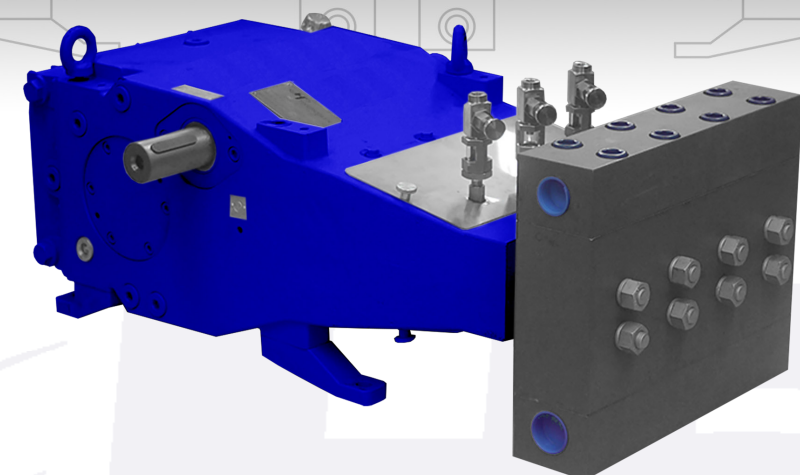
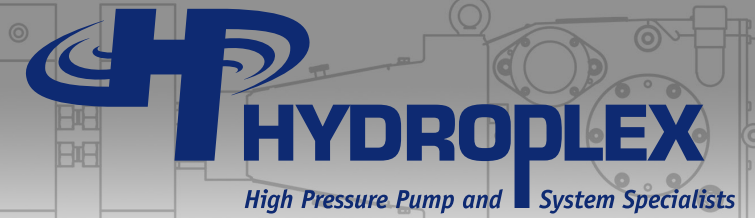

Features

- Pressure to 38,000 psi*
- Internal Helical Gear Reduction
- Durable and Compact
- Splash or Pressurized Lubrication Systems
- Easy Field Maintenance
- High Output Efficiency
- Corrosion Resistant Hardware

Applications

- Methanol Injection
- Hydrostatic Testing
- Chemical Injection
- Downhole Equalization
- Flushing
- HPU Charging

More

- Maximum Continuous Power 80 HP
- Maximum Intermittent Power 100 HP
- Internal Gear Ratio 3.95:1
- Maximum Continuous Input RPM 1430 RPM
- Maximum Intermittent Input RPM 2200 RPM
- 3.75" Stroke Length
- Available with 4-bolt SAE "C" female splined shaft for direct coupling of hydraulic motors

Features

- Pressure to 20,000 psi*
- Internal Helical Gear Reduction
- Durable and Compact
- Splash or Pressurized Lubrication Systems
- Easy Field Maintenance
- High Output Efficiency
- Corrosion Resistant Hardware

Applications

- Methanol Injection
- Hydrostatic Testing
- Chemical Injection
- Downhole Equalization
- Flushing
- HPU Charging
- Well Service

More

- Maximum Continuous Power 120 HP
- Maximum Intermittent Power 150 HP
- Internal Gear Ratio 3.69:1
- Maximum Continuous Input RPM 1350 RPM
- Maximum Intermittent Input RPM 2150 RPM
- 3.75" Stroke Length

Plunger Dia.	Maximum Pressure PSI	Gallons Per Input Revolution	Volumes							
			2200 RPM		2000 RPM		1800 RPM		100 RPM	
			GPM	BPD	GPM	BPD	GPM	BPD	GPM	BPD
7/16"	38,000*	.00185	4.07	140	3.70	127	3.33	114	.19	6.34
1/2"	30,000*	.0024	5.28	181	4.80	165	4.32	148	.24	8.22
5/8"	22,500*	.0038	8.36	287	7.60	261	6.84	235	.38	13.03
3/4"	15,000	.0054	11.88	407	10.80	370	9.72	333	.54	18.51
7/8"	10,000	.0074	16.28	588	14.80	507	13.32	457	.74	25.37
1"	8,000	.0096	21.12	724	19.20	658	17.28	593	.96	32.91
1-1/8"	6,300	.0122	26.84	920	24.40	836	21.96	753	1.22	42.00
1-1/4"	5,000	.0151	33.22	1,139	30.20	1,244	27.23	1,121	1.51	51.77

Plunger Dia.	Maximum Pressure PSI	Gallons Per Input Revolution	Volumes							
			2150 RPM		2000 RPM		1800 RPM		100 RPM	
			GPM	BPD	GPM	BPD	GPM	BPD	GPM	BPD
3/4"	20,000*	.0059	12.68	435	11.80	405	10.62	364	.59	20.22
7/8"	15,000	.0080	17.20	590	16.00	549	14.40	494	.80	27.44
1"	11,300	.0105	22.58	774	21.00	720	18.90	648	1.05	36.00
1-1/8"	9,000	.0132	28.38	973	26.40	905	23.76	815	1.32	45.28
1-3/16"	8,100	.0146	31.40	1,076	29.20	1,001	26.28	901	1.46	48.60
1-1/4"	7,200	.0163	35.05	1,201	32.60	1,118	29.34	1,005	1.63	55.83
1-3/8"	6,000	.0197	42.36	1,452	39.40	1,350	35.48	1,216	1.97	67.56
1-1/2"	5,000	.0234	50.31	1,725	46.80	1,604	42.12	1,444	2.34	80.22

Above flowrates based upon 100% volumetric efficiency
*Please consult with factory for pressures over 20,000 psi

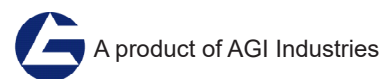

Hydroplex Corporation
230 W. Gloria Switch Rd.
Lafayette, LA 70507
337-233-0626
www.hydroplexpumps.com

Above flowrates based upon 100% volumetric efficiency
*Please consult with factory for pressures over 20,000 psi

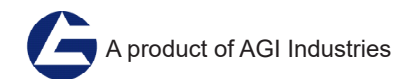

Hydroplex Corporation
230 W. Gloria Switch Rd.
Lafayette, LA 70507
337-233-0626
www.hydroplexpumps.com